



INDIGO COMBO

INSTALLATION GUIDE

THIS GUIDE IS FOR THE FOLLOWING LUMINAIRE VARIATIONS:







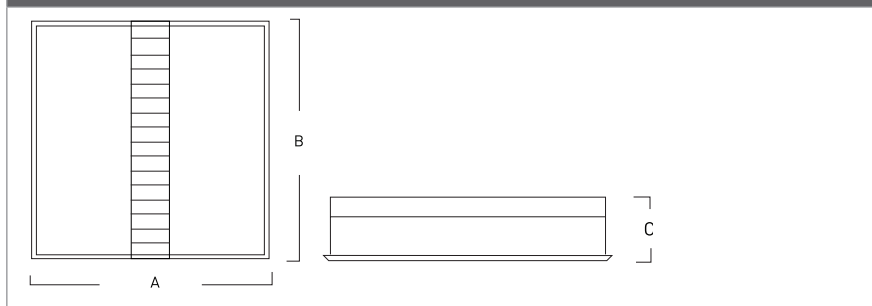

- + Exposed T-Bar
- + Plaster Recessed

- + PLEASE READ THIS GUIDE CAREFULLY BEFORE INSTALLING OR MAINTAINING THIS EQUIPMENT.
- + DATA SHOULD BE USED AS AN INDICATION ONLY.
- + GOOD ELECTRICAL PRACTICES SHOULD BE FOLLOWED AT ALL TIMES.
- + MUST ONLY BE INSTALLED BY A LICENSED ELECTRICIAN.

DIMENSIONS DIAGRAM



SPECIFICATION

-  Luminaire's light distribution is direct/indirect.
-  Denotes which light source/light sources that can be supplied with the luminaire. Several symbols next to the same luminaire indicate that the luminaire is available in different designs.
-  Luminaire is designed for the T5-light source's unique characteristics. The small diameter of the fluorescent lamp has created new conditions for light control.
-  **IP classification:**
IP20 : Protected against solid objects greater than 12 mm, e.g. persons fingers.
-  **Class I :** Appliances with functioning insulation. Equipped with an earth termination.
-  Luminaire can be obtained in designs with emLED.
-  Luminaire is available in designs for conventional emergency lighting operation.
-  This luminaire is not suitable for covering with thermally insulating material
-  RCM indicates a device's compliance with applicable ACMA technical standards.

WEIGHT: 5.5Kg (Nominal size 1200x300)

PRODUCT CODE	LIGHT SOURCE/DESCRIPTION	(NOM) DIMENSIONS				
		A	B	C	CUTOUT	
INDIGO COMBO EXPOSED T-BAR						
EL-24855-128-100-__	1 x 25/28W	300	1200	130		
EL-24856-228-100-__	2 x 25/28W	300	1200	130		
EL-24857-154-100-__	1 x 50/54W	300	1200	130		
EL-24871-128-100-__	1 x 25/28W	600	1200	130		
EL-24872-228-100-__	2 x 25/28W	600	1200	130		
EL-24873-154-100-__	1 x 50/54W	600	1200	130		
EL-24862-214-100-__	2 x 13/14W	600	600	130		
EL-24864-224-100-__	2 x 20/24W	600	600	130		
ACCESSORIES						
EL-ACC-601-000	Plaster Frame	600	600	93	605	605
EL-ACC-602-000	Plaster Frame	300	1200	102	310	1205
EL-ACC-603-000	Plaster Frame	600	1200	93	605	1205

INDIGO COMBO

INSTALLATION INSTRUCTIONS

The Indigo Combo luminaire is shipped as a complete luminaire with the exception of Plaster Recessed variations only, which come with additional brackets and fasteners.

Indigo Combo | T-Bar

- Step 1: Lift Indigo Combo body into ceiling cavity.
- Step 2: Complete electrical connection.
- Step 3: Position Indigo Combo body centrally within T-Bar.
- Step 4: Ensure lamp is fitted correctly.

Indigo Combo | Plaster Recessed

- Step 1: Cut-out the correct hole size in the ceiling for your Indigo Combo luminaire.
- Step 2: Lift plaster frame to plaster cutout.
- Step 3: Insert and fasten Plaster Recessed brackets into slots as indicated in Diagram A. Ensure fasteners are not overtightened.

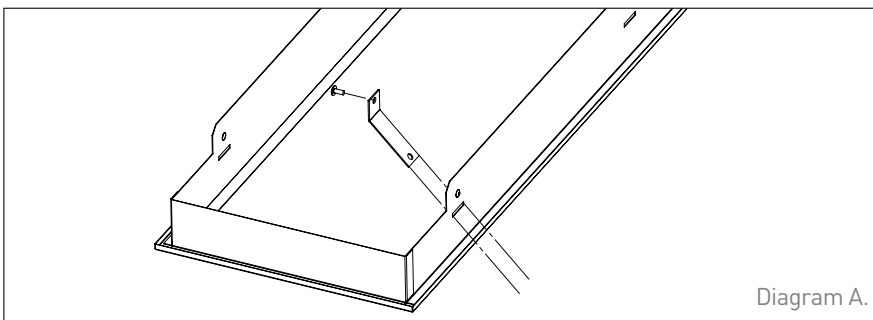
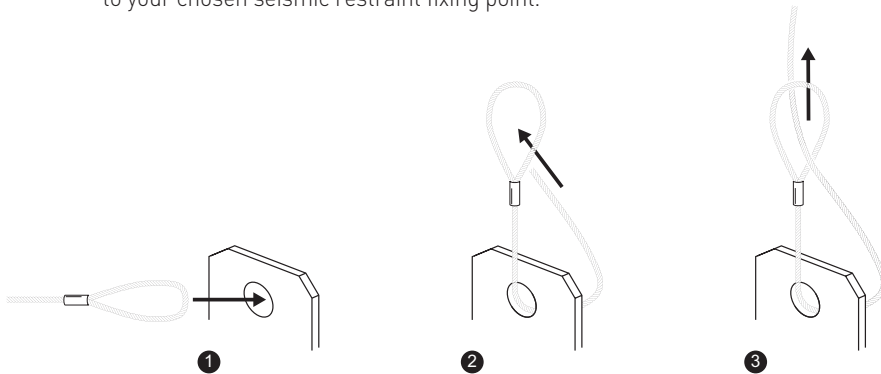

Diagram A.

- Step 4: Lift Indigo Combo luminaire into ceiling cavity.
- Step 5: Complete electrical connection.
- Step 6: Position luminaire centrally within plaster frame.
- Step 7: Ensure lamp is fitted correctly.

Seismic Restraint Installation

- Step 1: Thread suspension wire through seismic restraint tag.
- Step 2: Thread the free end of the suspension wire through the loop.
- Step 3: Attach the gripper to the free end, allowing enough wire to attach the free end to your chosen seismic restraint fixing point.



GENERAL INFORMATION

- + A qualified electrician, in accordance with AS/NZS 3000:2007 wiring regulations should carry out connection to mains wiring.
- + This unit must be EARTHED.
- + Ensure that the rated voltage and frequency requirements are compatible with the available mains supply, 220-240V 50Hz
- + Cleaning of reflectors and lenses should be carried out using clean, soft and lint free cloths and anti-static cleaning fluid.
- + Do not carry out high voltage insulation test i.e. 500/1000V this may damage the fixtures electrical components.

HEAD OFFICE | MELBOURNE
EAGLE LIGHTING VIC

17-19 Jets Court
Melbourne Airport VIC 3045
P 03 9344 7444
F 03 9344 7433

SYDNEY
EAGLE LIGHTING NSW

Unit 4, 21 Mars Road
Lane Cove NSW 2066
P 02 9420 5799
F 02 9420 5988

BRISBANE
EAGLE LIGHTING QLD

53 Caswell Street
East Brisbane QLD 4169
P 07 3891 0744
F 07 3891 0755

CANBERRA
EAGLE LIGHTING ACT

M 0411 889 406

eaglelightingaustralia
'Member of the Fagerhult Group'

EAGLE LIGHTING AUSTRALIA PTY LTD.
ABN 46 124 400 933